

INSTALLATION INSTRUCTIONS FOR ULTRA-LIGHT DUAL PIVOT CALIPER BRAKE

WARNING - to avoid serious injuries

• Improper use of your bicycle's brake system may result in a loss of control or an accident, which could lead to a severe injury. Because each bicycle may handle differently, be sure to learn the proper braking technique (including brake lever pressure and bicycle control characteristics) for your bicycle. Consult your bicycle dealer and the bicycle's owners manual, and practice your riding and braking technique.

• Securely tighten the caliper brake mounting nuts to the specified tightening torque. For recessed nut type brakes: Use recessed nuts of the appropriate length which can be turned six times or more; when re-installing, apply sealant (locking adhesive) to the nut threads.

• If the nuts become loose and the brakes fall off, they could get caught up in the bicycle and the bicycle may fall over. Particularly if this happens with the front wheel the bicycle may be thrown forward and serious injury could result.

• Brakes designed for use as rear brakes should not be used as front brakes and vice versa.

• Obtain and read the service instructions carefully prior to installing the brakes. Loose, worn, or damaged parts may cause serious injury.

• Be careful not to allow any oil or grease to get onto the brake shoes, if oil or grease gets on the pads, the pads should be replaced, and the braking surface of the rims should be cleaned carefully, otherwise the brakes may not work properly.

• Always make sure that the front and rear brakes are working correctly before you ride the bicycle.

• The required braking distance will be longer during wet weather. Reduce your speed and apply the brakes early and gently.

• If the road surface is wet, the tires will skid more easily. If the tires skid, you may lose control of the bicycle. To avoid this, reduce your speed and apply the brakes early and gently.

• Read these Technical Service Instructions carefully, and keep them in a safe place for later reference.

NOTE:

• If using standard TRP brake pads in combination with ceramic or carbon fiber rims, the brakes shoes will wear more quickly than normal. Pads specifically designed for carbon fiber rim surfaces are available from TRP.

• If the brake pads have worn down until the grooves are no longer visible, they should be replaced.

• Parts are not guaranteed against natural wear or deterioration resulting from normal use or crash damage.

• For any questions regarding methods of handling or maintenance, please contact the original place of purchase.

A - Installation of the brake

Compress the brake arms to press the pads into contact with the rim to center the brake while tightening the center bolt fixing nut. **Tightening torque: 6-8 Nm.**

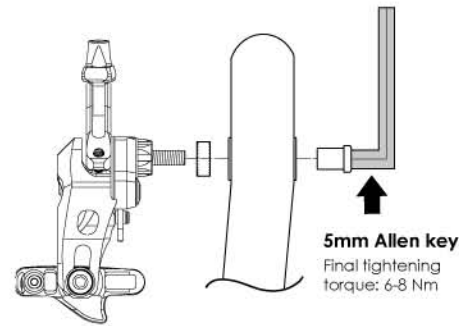

B - Brake shoe setting position

Adjust the brake pad position so that the shoe surface aligns with the rim surface as shown in the illustration, tighten the shoe fixing bolt.

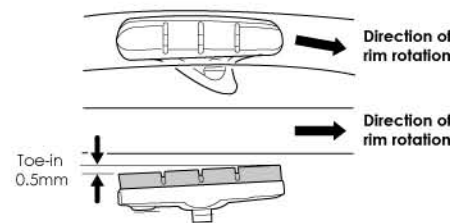

NOTE- TRP road brakes allow the angle of contact between the shoe and the rim (Toe-in) to be adjusted. Adjusting the Toe-in makes it possible to obtain smoother braking operation.

C - Cable connection

Ensure that the cable barrel adjuster is seated in place.

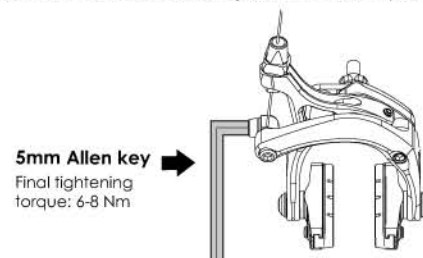

D - Centering the brake

Using the centering adjustment bolt for minor adjustment. Turn the cable barrel adjuster to readjust the pad clearance.

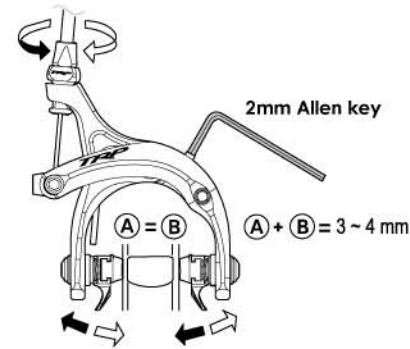

E - Check

Depress the brake lever about 10 times as far as the handlebar and check that everything is operating correctly and that the shoe clearance is correct before using the brakes.

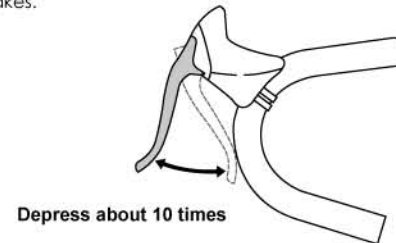

Operation of the quick release SL Models

Compress the brake arms with one hand so that the pads make contact with the rim. With the other hand, pull upward and inward on the cable barrel adjuster to slide the cable into the open area of the brake arm.

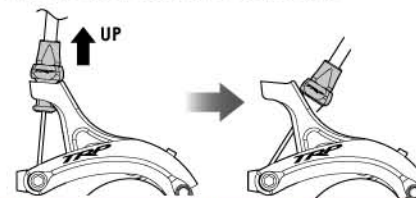

Note: The braking power will be greatly reduced with the quick release in the open position. Under no circumstances should bicycle be ridden with the quick release in the open position.

Operation of the quick release EQ Models

R970EQ and R979EQ models incorporate a traditional cam style quick release. To release the brake arms for tire removal, turn the cam release lever upwards.

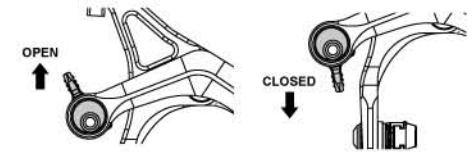

NOTE: The bicycle should only be ridden with the cam release lever in the fully closed (down) or fully open (up) positions. Actuating the brakes while the cam release lever is between fully closed and fully open may result in a sudden loss of braking power.

Replacement of the cartridge pad

Remove the fixing bolt. Remove the pad by sliding it along the groove of the pad holder.

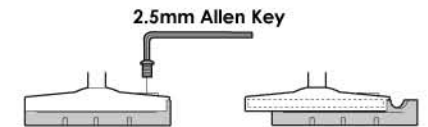

There are two different types of pad and pad holder to be used in the left and right positions respectively. Slide the new pad into the grooves on the pad holders while taking note of the correct directions and bolt hole positions.

FOR THE LEFT
Same at front and rear.

FOR THE RIGHT
Same at front and rear.

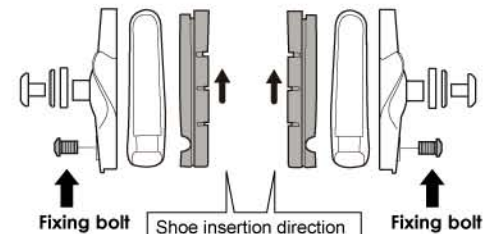

Tighten the fixing bolt. **Tightening torque: 1-1.5 Nm.**

QUESTIONS?

For questions about setup, usage or general inquiries, please e-mail or call toll free at:

TRP Brakes
info@trpbrakes.com
1-877-807-4162
www.trpbrakes.com